

鍊條配件 / *Fittings for chain*

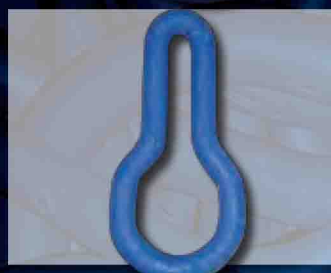

吊鈎 Hooks



吊鈎-SK 碼 Slinghook - code SK

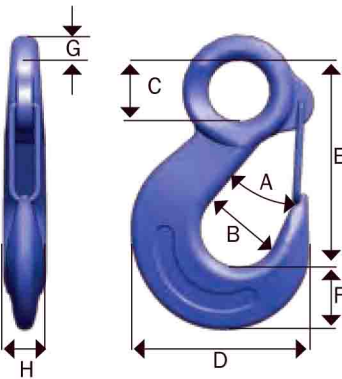

Varenr Item no.	Dim Code	WLL 4:1 tonn	Mål i mm/dim mm								kg N.W.
			A	B	C	D	E	F	G	H	
0302101	SK-41	2,5	32	34	26	84	95	35	12	20	0,5
2	SK-42	4,3	40	45	35	109	126	40	16	25	1,0
3	SK-43	6,2	48	54	46	134	150	49	18	31	2,0
4	SK-44	8,5	53	62	51	158	173	57	21	35	2,8
5	SK-45	12,5	63	73	58	184	200	71	25	48	5,5
6	SK-46	20,0	69	84	53	208	218	81	30	54	7,6
7	SK-49	31,5	106	117	73	279	316	104	42	70	22,0

Rep.sett, se side 27

眼型鑄造鈎-YK 碼 Eye foundry hook - code YN

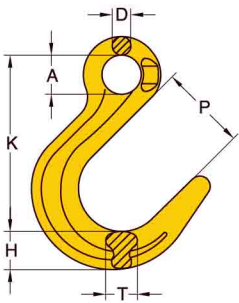

Varenr Item no.	WLL 4:1 tonn	For kjett. For chain dim	Type Code	Mål i mm/dim mm						kg N.W.
				K	P	A	D	T	H	
0312411	2,00	7-8	YN-7/8	122	61	24	12	20	30	0,7
2	3,15	10	YN-10	150	74	31	15	24	34	1,2
3	5,30	13	YN-13	180	88	40	20	34	42	2,5
4	8,00	16	YN-16	215	98	49	24	43	50	4,0
5	12,50	18-20	YN-18/20	248	112	60	28	46	57	6,6

NS-EN 1677-1

大型袋專用鈎 Hooks for big bag

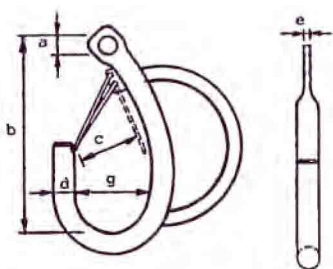

Varenr Item no.	Dim. Code	WLL 4:1 tonn	Mål i mm/dim mm						kg N.W.
			a	b	c	d	e	g	
0302503	M 2,5	2,5	23	248	65	32	16	80	3,5
4	M 4	4	26	264	70	38	21	90	5,0

吊鈎 Hooks



管鈎 Pipe hooks

Krokene kan leveres med plater, gummibelagt. WLL pr. par, ved 30-45°
Also rubber coated. WLL a pair at 30-45° working angel.

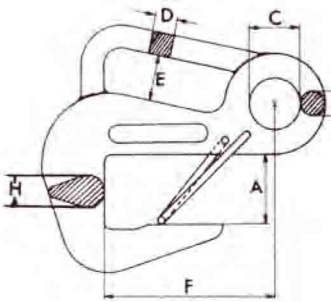

Varenr Item no.	Dim Code	WLL 4:1 tonn	Mål i mm/dim mm							kg N.W.
			A	B	C	D	E	F	H	
0302601	PH-1	6,8	65	22	50	22	42	165	32	4,4
2	PH-0,6	0,6	23	15	17	9	35	65	12	0,9

容器配件 Container fittings

Platetykkelse 16 mm/Thickness 16 mm.

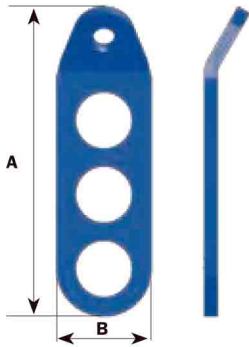

Varenr Item no.	Dim Code	WLL 4:1 tonn	For kjett. For chain Dim.	Kopl. Coupling element	Hull Hole dia. mm	Antall hull Number of hole	Mål i mm dim mm		kg N.W.
							A	B	
0310026	CBN-5,4-1	5,4	13	GM 13	64	1 N*	280	110	2,35
25	CB-5,4-3	5,4	13	GM 13	64	3	360	110	3,05
27	CB-5,4-5	5,4	13	GM 13	64	5	565	120	5,35
28	CBN-5,4-3	5,4	13	GM 13	64	3 N*	514	100	3,95

N=Nøkkelhull/Keyhole

眼型容器吊鈎 Eye container hook – code KA

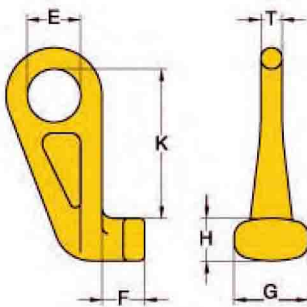

Varenr Item no.	WLL 4:1 tonn	Type Code	Mål i mm/dim mm						kg N.W.
			K	E	F	T	G	H	
0312492	12,5	KA-S traight	192	70	46	25	75	48	4,0
90	12,5	KA-Left 45°	192	70	46	25	75	48	4,0
91	12,5	KA-Right 45°	192	70	46	25	75	48	4,0

NS-EN 1677-1

備品

Spare parts



備品

Spare parts

For selvukkende kroker type YC, YE og YD
For self locking hook code YC, YE and YD.

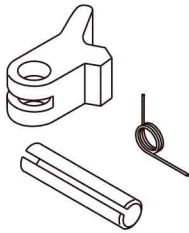

Varenr Item no.	Størrelse Size mm.
0312851	7
2	10
3	13
4	16
5	18/20
6	22
7	26
8	32

備品

Spare parts

For slavekrok med gaffel type YM
For clevis sling hook code YM

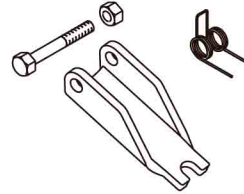

Varenr Item no.	Størrelse Size mm.
0312331	7
2	10
3	13
4	16
5	18/20
6	22
7	26
8	32

PH型鉤備品

Spare parts for PH-hooks

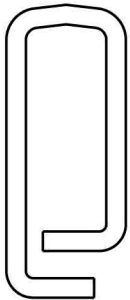

Varenr Item no.	Dim Code
0302604	PH 0,6
3	PH 1

怪手用鉤備品

Spare parts for excavator hook

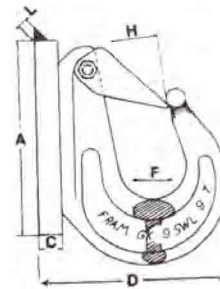

Varenr Item no.	Dim Code
0302912	SKG-14000
3	GK-9

SK型吊鉤彈簧

Spring for SK-hooks

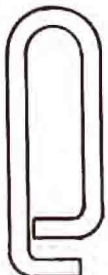

Varenr Item no.	Dim Code
0302201	SK-41
2	SK-42
3	SK-43
4	SK-44
5	SK-45
6	SK-46
7	SK-49
*0302217	SK-49

*Latch, bolt and spring.

插銷套件

Load pin kit

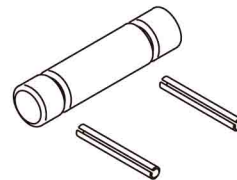

Varenr Item no.	WLL Tonn	Dim Code
0312860	6	1,2
1	7	2,0
2	10	3,15
3	13	5,3
4	16	8,0
5	18/20	12,5