

戰車型移動滾輪 MOVING ROLLERS

ROLLERS

本產品用來移動重物

PRODUCTS THAT MOVE THE HEAVYWEIGHTS



戰車型移動滾輪 MOVING ROLLERS

ROLLERS

實績和認證 USER'S REFERENCE & CERTIFICATE

ROLLERS

Since 1953, **Rollers** has produced high capacity roller dollies of the highest quality. Early customers used **Rollers** primarily for installing and relocating machinery. Over the years **Rollers** have been put to the test in a much greater variety of applications.

Some markets where

Rollers have proven to be useful:

- Aerospace
- Oil & Gas Exploration
- Refineries & Petrochemical Plants
- Bridge Construction
- Nuclear & Electric Power Generation
- Structural Moves
- Research Laboratories
- Shield Doors
- Shipbuilding & Marine Structures
- Quick Die Transfer
- Manufactured Housing
- Mining
- Railroads & Transportation
- Fabrication
- Commercial & Industrial

Rollers' mission statement summarizes our commitment to our customers.

Rollers strives to provide the finest quality products at a fair price and in a timely manner, to work as equal partners with our customers and distributors by assessing their needs and providing the right products to meet or exceed those requirements; to constantly improve quality and reduce cost through continued improvement of each internal department; and to provide proper support by maintaining a knowledgeable staff who possess the tools and technology to perform their jobs.

Rollers can design, prototype, test and produce steel fabrications such as transfer tables and carts, heavy industrial conveyor lines as well as the track that the rollers ride on.

has gained the approval of DNV, Lloyd's, BV, SGS, ABS and other third parties; and is certified ISO-9001:2000 and CE approved.

Our staff is available to go anywhere in the world to consult with you about your projects.



FT系列(重量級)

FT SERIES

豪華組件15~60噸(包括鐵盒)

- **DELUXE KITS 15 - 60 TONS**
- **ECONOMY SETS 15 - 200 TONS**

經濟型組15~200噸

Everything required to make heavy moves up to 200 tons is included in **Deluxe Kits and Economy Sets!** Both include four swivel locking **Rollers** with either padded or diamond steel tops and two steering handles. Four preload pads are also included with rollers having the SLD style top. Sets contain full length steering handles. Kits contain knock down handles that fit into a sturdy storage case. Kit cases are lockable and have lifting grips for easy handling, providing protection from exposure and theft. Each kit or set provides the necessary gear to tackle a moving project up to that respective capacity.



Deluxe FT Kit

各別滾輪3.75~50噸

- **INDIVIDUAL ROLLERS**
- 3.75 - 50 TONS**

With six capacities, two moving types (rigid and swivel locking) and three top styles (padded, diamond steel and smooth steel), there's a model perfect for almost every heavy moving applications in this

Rollers series! For straight line moves, specify the rigid roller. For turns, even in the tightest of corners, use the swivel locking rollers. The swivel-locking type combines swivel and rigid designs with spring loaded locks that can engage every 45 degrees. Steering handles are available for Swivel Lock types in 3 lengths. H36F (36" / 914 mm), H48" (48" / 1219 mm) and H60F (60" / 1524 mm).

FT Series **Rollers** have three versatile top plates. "D" tops have a spike-like steel grid able to grip into wood and provide a secure move for crated or palletized equipment. "P" tops, with built-in neoprene pad, allow some compression and provide a non-slip surface, a versatile choice for moving on less than perfect floors or for moving metal based machines. "S" tops have smooth steel top, ideal for mounting the rollers to equipment or as a base unit for a variety of top modifications.

SWIVEL-LOCKING

RIGID



KIT / SET CAPACITY (TONS)	KIT / SET PRODUCT NUMBER	KIT / SET INCLUDES (All kits include steel cases) Kit Box KD-D2: 27.75" (705mm) x 14.75" (375mm) x 9.63" (245mm)	WEIGHT lb.	kg.
15	KRS-15-SLP	(4) 3.75-SLP Rollers; (2) KD48F Handles	203	92
15	RS-15-SLP	(4) 3.75-SLP Rollers; (2) H36F 36" Handles	156	71
15	KRS-15-SLD	(4) 3.75-SLD Rollers; (4) P-1 Preload Pads; (2) KD48F Handles	203	92
15	RS-15-SLD	(4) 3.75-SLD Rollers; (4) P-1 Preload Pads; (2) H36F 36" Handles	156	71
30	KRS-30-SLP	(4) 7.5-SLP Rollers; (2) KD48F Handles	215	98
30	RS-30-SLP	(4) 7.5-SLP Rollers; (2) H48F 48" Handles	172	78
30	KRS-30-SLD	(4) 7.5-SLD Rollers; (4) P-1 Preload Pads; (2) KD48F Handles	215	98
30	RS-30-SLD	(4) 7.5-SLD Rollers; (4) P-1 Preload Pads; (2) H48F 48" Handles	172	78
40	KRS-40-SLP	(4) 10-SLP Rollers; (2) KD48F Kit Size Handles	219	99
40	RS-40-SLP	(4) 10-SLP Rollers; (2) H48F 48" Handles	176	80
40	KRS-40-SLD	(4) 10-SLD Rollers; (4) P-1 Preload Pads; (2) KD48F Handles	219	99
40	RS-40-SLD	(4) 10-SLD Rollers; (4) P-1 Preload Pads; (2) H48F 48" Handles	176	80
60	KRS-60-SLP	(4) 15-SLP Rollers; (2) KD48F Kit Size Handles	255	116
60	RS-60-SLP	(4) 15-SLP Rollers; (2) H48F 48" Handles	212	96
60	KRS-60-SLD	(4) 15-SLD Rollers; (4) P-1 Preload Pads; (2) KD48F Handles	259	117
60	RS-60-SLD	(4) 15-SLD Rollers; (4) P-1 Preload Pads; (2) H48F 48" Handles	216	98
120	KRS-120-SLP	(4) 30-SLP Rollers; (2) H60F 60" Handles	542	256
120	RS-120-SLD	(4) 30-SLD Rollers; (4) P-2 Preload Pads; (2) H60F 60" Handles	540	245
200	RS-200-SLP	(4) 50-SLP Rollers; (2) H60F 60" Handles	834	378
200	RS-200-SLD	(4) 50-SLD Rollers; (4) P-2 Preload Pads; (2) H60F 60" Handles	848	385



Economy FT Set

CAPACITY (TONS)	PRODUCT NUMBER	TOP STYLE	HEIGHT		WIDTH		LENGTH		WEIGHT		CONTACT ROLLS
			in	mm	in	mm	in	mm	lb	kg	
3.75*	3.75-SLP		5	127	5-3/4	146	10-1/2	267	34	15	5
7.5*	7.5-SLP	SWIVEL	5-1/4	133	5-3/4	146	10-1/2	267	38	17	4
10*	10-SLP	LOCKING	5-1/4	133	5-3/4	146	10-1/2	267	38	17	4
15	15-SLP	PADDED	5-1/8	130	6-3/8	162	12-3/4	324	49	22	5
30*	30-SLP		8	203	8	203	15	381	122	55	5
50*	50-SLP		8-15/16	227	8	203	21	533	193	88	7
3.75*	3.75-SLD	SWIVEL	4-3/4	121	5-3/4	146	10-1/2	267	34	15	5
7.5*	7.5-SLD	LOCKING	5	127	5-3/4	146	10-1/2	267	37	17	4
10*	10-SLD	WITH	5	127	5-3/4	146	10-1/2	267	37	17	4
15	15-SLD	DIAMOND	4-7/8	124	6-3/8	162	12-3/4	324	49	22	5
30	30-SLD	STEEL	7-3/32	180	8	203	15	381	118	54	5
50	50-SLD	GRID	8-1/16	205	8	203	21	533	189	86	7
3.75*	3.75-SLS		4-5/8	117	6	152	10-1/2	267	35	16	5
7.5*	7.5-SLS	SWIVEL	4-7/8	124	6	152	10-1/2	267	38	17	4
10*	10-SLS	LOCKING	4-7/8	124	6	152	10-1/2	267	38	17	4
15	15-SLS	WITH	4-3/4	121	6-3/8	162	12-3/4	324	50	23	5
30	30-SLS	SMOOTH	6-31/32	177	8	203	15	381	119	54	5
50	50-SLS	STEEL	7-15/16	202	8	203	20-7/8	530	191	87	7
3.75*	3.75-RP		4-3/16	106	5-3/4	146	10-1/2	267	29	13	5
7.5*	7.5-RP		4-7/16	113	5-3/4	146	10-1/2	267	33	15	4
10*	10-RP	RIGID	4-7/16	113	5-3/4	146	10-1/2	267	33	15	4
15	15-RP	PADDED	4-5/16	110	6-3/8	162	12-3/4	324	42	19	5
30*	30-RP		6-3/4	171	8	203	15	381	107	49	5
50*	50-RP		7-3/4	197	8	203	21	533	179	81	7
3.75*	3.75-RD		4-1/16**	103	5-5/8	143	10-1/2	267	29	13	5
7.5*	7.5-RD	RIGID	4-5/16**	110	5-5/8	143	10-1/2	267	32	15	4
10*	10-RD	WITH	4-5/16**	110	5-5/8	143	10-1/2	267	32	15	4
15	15-RD	DIAMOND	4-3/32**	104	6-3/8	162	12-3/4	324	38	17	5
30*	30-RD	STEEL	6-1/8**	156	8	203	15	381	105	48	5
50*	50-RD	GRID	7-1/8**	181	8	203	21	533	176	80	7
3.75*	3.75-RS		3-11/16	94	5-5/8	143	10-1/2	267	29	13	5
7.5*	7.5-RS	RIGID	3-15/16	100	5-5/8	143	10-1/2	267	32	15	4
10*	10-RS	WITH	3-15/16	100	5-5/8	143	10-1/2	267	32	15	4
15	15-RS	SMOOTH	3-13/16	97	6-3/8	162	12-3/4	324	43	20	5
30*	30-RS	STEEL	5-3/4	146	8	203	15	381	105	48	5
50*	50-RS		6-3/4	171	8	203	21	533	176	80	7

* Width dimension of top exceeds roller frame width

** Height to top of spike

ERS系列(重量級)

ERS SERIES

豪華組件15~50噸(包括鐵盒)

- **DELUXE KITS 15 - 50 TONS**
 - **ECONOMY SETS 15 - 400 TONS**
- 經濟型組15~400噸



With or without a kit case, these prepackaged Kits or Sets are the value leaders of the **Roller** line. Economy Sets, without kit boxes, are available in capacities from 15 to 400 tons. Deluxe Kits and Economy Sets contain four basic ERS Rollers, which can be used as is for straight line moving. Four swivel locking attachments with diamond steel tops are included, along with four preload pads and two steering handles. Handles in the Sets vary in length according to the capacity of the rollers; Kit handles are a two piece knockdown style to fit into the steel case. All the deluxe gear necessary for your important project is provided.

KIT/SET CAPACITY (TONS)	KIT AND SET PRODUCT NUMBER	KIT / SET INCLUDES (ALL KITS Include Steel Cases)	WEIGHT	
			lb	kg
15	KRS-15-ERSD	(4) 3.75-ERS Rollers	181	82
15	RS-15-ERSD	(4) T-3.75-LD Swivel Locking Diamond Attachments (4) P-1 Preload Pads (2) KDH48E Kit Size Handles in Kit Or (2) H36E 36" Handles in Set	130	59
20	KRS-20-ERSD	(4) 5-ERS Rollers	201	91
20	RS-20-ERSD	(4) T-5-LD Swivel Locking Diamond Attachments (4) P-1 Preload Pads (2) KDH48E Kit Size Handle in Kit Or (2) H36E 36" Handles in Set	150	68
40	KRS-40-ERSD	(4) 10-ERS Rollers	241	109
40	RS-40-ERSD	(4) T-10-LD Swivel Locking Diamond Attachments (4) P-1 Preload Pads (2) KDH48E Kit Size Handles in Kit Or (2) H48E 48" Handles in Set	196	89
50	KRS-50-ERSD	(4) 12.5-ERS Rollers	249	113
50	RS-50-ERSD	(4) T-12.5-LD Swivel Locking Diamond Attachments (4) P-1 Preload Pads (2) KDH48E Kit Size Handles in Kit Or (2) H48E 48" Handles in Set	204	93
100	Kit Not Available RS-100-ERSD	(4) 25-ERS Rollers (4) T-25-LD Swivel Locking Diamond Attachments (4) P-2 Preload Pads (2) H48E 48" Handles in Set	514	233
260	Kit Not Available RS-260-ERSD	(4) 65-ERS Rollers (4) T-65-LD Swivel Locking Diamond Attachments (4) P-2 Preload Pads (2) H60E 60" Handles in Set	870	395
400	Kit Not Available RS-400-ERSD	(4) 100-ERS Rollers (4) T-100-LD Swivel Locking Diamond Attachments (4) P-2 Preload Pads (2) H60E 60" Handles in Set	906	411



各別滾輪3.75~100噸

• INDIVIDUAL ROLLERS 3.75 - 100 TONS

ERS rollers are the lowest profile high capacity rollers in the world! Utilizing the endless chain concept, the basic individual ERS Roller is designed for straight line motion, yet each can be outfitted with a removable swivel attachment for turning and positioning. Seven capacities are available.

旋轉配件

• SWIVEL ATTACHMENTS

For the ultimate versatility, each ERS Series Roller can be outfitted with an ERS Swivel Attachment. Attachments add minimal height to the basic roller, while providing ability to make turns without jacking the equipment. Featuring chrome steel ball bearings for smooth operation, attachments come with diamond steel or padded tops and swivel locking devices. Padded attachments help minimize metal-to-metal slippage. Height Equalizers, which increase the height of the roller to that of a roller without swivel attachment, are also available for each roller size.



CAP (TONS)	PRODUCT NUMBER	HEIGHT		WIDTH		LENGTH		WEIGHT		CONTACT ROLLS
		in	mm	in	mm	in	mm	lb	kg	
3.75	3.75-ERS	2 - 3/4	70	4 - 7/16	113	8 - 5/8	219	15	7	5
5	5-ERS	2 - 3/4	70	5 - 5/16	135	8 - 5/8	219	18	8	5
10	10-ERS	3 - 3/8	86	5 - 3/16	132	10 - 3/8	264	28	13	5
12.5	12.5-ERS	3 - 3/8	86	5 - 5/8	143	10 - 3/8	264	30	14	5
25	25-ERS	4 - 3/4	121	7 - 1/4	184	15 - 3/4	400	79	36	5
65	65-ERS	5 - 5/8	143	7 - 3/8	187	23	584	152	69	7
100	100-ERS	5 - 5/8	143	7 - 7/8	200	23	584	166	75	7



PRODUCT NUMBERS		FITS INDIVIDUAL ROLLER PRODUCT NUMBER	* ATTACHMENT PLUS ROLLER				ATTACHMENT WIDTH		LENGTH *		WEIGHT	
SWIVEL LOCKING DIAMOND GRIP TOP	SWIVEL LOCKING PADDED TOP		PADDED (P) STYLE HEIGHT *	DIAMOND (D) STYLE HEIGHT *			in	mm	in	mm	lb	kg
T-3.75-LD	T-3.75-LP	3.75-ERS	4 - 11/16	119	4 - 7/16	113	5 - 7/8	149	10 - 3/4	273	13	6
T-5-LD	T-5-LP	5-ERS	4 - 11/16	119	4 - 7/16	113	5 - 7/8	149	10 - 3/4	273	13	6
T-10-LD	T-10-LP	10-ERS	5 - 5/16	135	5 - 1/16	129	5 - 7/8	149	12 - 1/2	318	14	6
T-12.5-LD	T-12.5-LP	12.5-ERS	5 - 5/16	135	5 - 1/16	129	5 - 7/8	149	12 - 1/2	318	14	6
T-25-LD	T-25-LP	25-ERS	7 - 15/16	202	7 - 1/16	179	8	203	18 - 19/32	472	42	19
T-65-LD	T-65-LP	65-ERS	8 - 13/16	224	7 - 15/16	202	8 - 3/8	213	25 - 3/8	645	47	21
T-100-LD	T-100-LP	100-ERS	8 - 13/16	224	7 - 15/16	202	8 - 3/8	213	25 - 3/8	645	47	21

輕量級系列

LIGHT DUTY SERIES

索具組件和組3和8噸

• RIGGERS KITS AND SETS 3 AND 8 TONS

Handy Riggers Kits and Sets are sure to be the most valuable maintenance tools in the crib! With a limitless variety of uses, they provide the ability to move up to 3 tons or 8 tons. Both Sets and Kits contain two steering handles and four padded rollers, which are offered either with all four swivel tops or with two swivel and two rigid tops. Sturdy carrying cases store all items in the kits. Sets are provided without the case.



KRS-3-4S

RS-8-2S/2R

KIT / SET CAPACITY (TONS)	ROLLER CAPACITY (TONS)	KIT / SET PRODUCT NUMBER	KIT / SET INCLUDES (All KITS include steel cases) Steel Case Kit Box KB-D1: 16" (406mm) x 12.375" (314) x 4.44" (113mm)	WEIGHT lb	kg
3	0.75	KRS-3-4S	(4) 0.75-SP Rollers, (2) 3-KH Handles	55	25
3	0.75	RS-3-4S	(4) 0.75-SP Rollers, (2) 3-KH Handles	52	24
3	0.75	KRS-3-2S/2R	(2) 0.75-SP Rollers, (2) 0.75-RP Rollers, (2) 3-KH Handles	55	25
3	0.75	RS-3-2S/2R	(2) 0.75-SP Rollers, (2) 0.75-RP Rollers, (2) 3-KH Handles	52	24
8	2	KRS-8-4S	(4) 2-SP Rollers, (2) 8-KH Handles	85	39
8	2	RS-8-4S	(4) 2-SP Rollers, (2) 8-KH Handles	76	35
8	2	KRS-8-2S/2R	(2) 2-SP Rollers, (2) 2-RP Rollers, (2) 8-KH Handles	85	39
8	2	RS-8-2S/2R	(2) 2-SP Rollers, (2) 2-RP Rollers, (2) 8-KH Handles	76	35

• INDIVIDUAL ROLLERS .75 AND 2 TONS 個別滾輪0.75和2噸

Featuring endless chain action design, Light Duty Series Rollers come in either rigid or swivel type. Both versions are available topped with rugged no-slip pads or in a smooth top style, ideal for permanent mounting applications. Light Duty Series Rollers are low in height and high in capacity, combining the advantages of minimal lifting with controlled moving. Steering handle models 3-KH (15" / 381 mm) and 8-KH (30" / 762 mm) are available for .75 and the 2 ton swivel rollers.



SP

RP

CAPACITY (TONS)	PRODUCT NUMBER	TOP STYLE	HEIGHT in	mm	WIDTH in	mm	LENGTH in	mm	WEIGHT lb	kg	CONTACT ROLLS
.75	.75-SP	SWIVEL	3-5/16	84	3-5/8	92	6-1/2	165	9	4	5
2	2-SP	PADDED	3-15/16	100	4-1/8	105	6-1/2	165	15	7	4
.75	.75-SS	SWIVEL	3-5/16	84	3-5/8	92	6-1/2	165	9	4	5
2	2-SS	SMOOTH	3-11/16	94	4-1/8	105	6-1/2	165	15	7	4
.75	.75-RP	RIGID	3-1/8	79	3-5/8	92	6-1/2	165	9	4	5
2	2-RP	PADDED	3-5/8	92	4-1/8	105	6-1/2	165	15	7	4
.75	.75-RS	RIGID	2-3/4	70	3-5/8	92	6-1/2	165	9	4	5
2	2-RS	SMOOTH	3-1/4	83	4-1/8	105	6-1/2	165	15	7	4

NYTON SERIES

NYTON系列

NYTON組件2~24噸(包括鐵盒)

• NYTON KITS 2 - 24 TONS • NYTON SETS 2 - 40 TONS NYTON組2~40噸

Moving heavy equipment on delicate floors? Hilman's Nyton Kits and sets are for you! These conveniently prepackaged Kits and Sets provide the advantage of a heavy duty chain action roller that can safely move equipment on modern coated, painted or epoxy topped floors without scarring the surface. Nyton Kits come with a heavy duty, lockable case to store all items between moves. All Kits and Sets contain four padded swivel rollers and two steering handles. The rollers in the larger kit capacities from 8 tons and up feature swivel locking devices.



Economy Nyton Set

Deluxe Nyton Kit

• INDIVIDUAL ROLLERS .5 - 10 TONS 個別滾輪0.5~10噸



N3-RP

N.5-SP

N6-SLP

Combine solid, high impact nylon roll material with continuous chain action design and the result is NYTON - a high capacity moving device that protects delicate floor surfaces during heavy moves. 1/2 and 1 ton capacity Nyton Rollers are available in padded swivel or rigid styles. 2, 3, 6 and 10 ton capacities are available in padded swivel-locking or rigid styles. All tops feature built-in pads, providing a non-slip surface able to compress over uneven surfaces, giving further floor surface protection. Steering handles are available for these rollers. 3-KH (15" / 381 mm) and 8-KH (30" / 762 mm) for the 1/2 and 1 ton capacity Swivel Nyton rollers. H36F (36" / 914 mm), H48F (48" / 1219 mm), H60F (60" / 1524 mm) for the 2 ton and up Swivel Locking Nyton rollers.

KIT / SET CAPACITY (TONS)	KIT / SET PRODUCT NUMBER	KIT / SET INCLUDES (All KITS include steel cases)	WEIGHT lb	kg
2	KNRS-2-4S	(4) N.5-SP Rollers, (2) 3-KH Handles	47	21
2	NRS-2-4S	(4) N.5-SP Rollers, (2) 3-KH Handles	44	20
2	KNRS-2-2S/2R	(2) N.5-SP Rollers, (2) N.5-RP Rollers, (2) 3-KH Handles	45	20
2	NRS-2-2S/2R	(2) N.5-SP Rollers, (2) N.5-RP Rollers, (2) 3-KH Handles	42	19
4	KNRS-4-4S	(4) N1-SP Rollers, (2) 8-KH Handles	69	31
4	NRS-4-4S	(4) N1-SP Rollers, (2) 8-KH Handles	60	27
4	KNRS-4-2S/2R	(2) N1-SP Rollers, (2) N1-RP Rollers, (2) 8-KH Handles	69	31
4	NRS-4-2S/2R	(2) N1-SP Rollers, (2) N1-RP Rollers, (2) 8-KH Handles	60	27
8	KNRS-8-SLP	(4) N2-SLP Rollers, (2) KD48F Kit Size Handles	179	81
8	NRS-8-SLP	(4) N2-SLP Rollers, (2) H48F 48" Handles in Set	136	62
12	KNRS-12-SLP	(4) N3-SLP Rollers, (2) KD48F Kit Size Handles	179	81
12	NRS-12-SLP	(4) N3-SLP Rollers, (2) H48F 48" Handles in Set	136	62
24	KNRS-24-SLP	(4) N6-SLP Rollers, (2) KD48F Kit Size Handles	203	92
24	NRS-24-SLP	(4) N6-SLP Rollers, (2) H48F 48" Handles in Set	160	73
40	NRS-40-SLP	(4) N10-SLP Rollers, (2) H60F 60" Handles	458	208

CAPACITY (TONS)	PRODUCT NUMBER	HEIGHT in	mm	WIDTH in	mm	LENGTH in	mm	WEIGHT lb	kg	CONTACT ROLLS
.5	N.5-SP	3-7/16	87	3-5/8	92	6-1/2	165	7	3	5
1	N1-SP	3-15/16	100	4-1/8	105	6-1/2	165	12	5	4
2	N2-SLP*	5	127	5-3/4	146	10-1/2	267	28	13	5
3	N3-SLP*	5-1/4	134	5-3/4	146	10-1/2	267	29	13	4
6	N6-SLP	5-1/8	130	6-3/8	162	12-3/4	324	36	16	5
10	N10-SLP	7-31/32	202	8	203	15	381	100	45	5
.5	N.5-RP	3-1/8	80	3-5/8	92	6-1/2	165	6	3	5
1	N1-RP	3-5/8	92	4-1/8	105	6-1/2	165	11	5	4
2	N2-RP*	4-3/16	107	5-3/4	146	10-1/2	267	23	10	5
3	N3-RP*	4-7/16	113	5-3/4	146	10-1/2	267	24	11	4
6	N6-RP	4-5/16	110	6-3/8	162	12-3/4	324	31	14	5
10	N10-RP	6-3/4	171	8	203	15	381	86	39	5

*Width dimension of top exceeds roller frame width

OT, NT, T系列 OT, NT, T SERIES

INDIVIDUAL ROLLERS .75 - 75 TONS

個別滾輪0.75~75噸



A variety of top plate styles, exceptionally strong materials of construction and a wide range of modification possibilities make OT, T and NT Rollers the true OEM leaders of the **Roller** line! Rollers in this series are built for long life and a wide range of operating conditions. For basic linear motion, these rollers are used as bearing sides, conveyors, guides, casters or dollies. Typical applications include the straight motion required for thermal expansion under a furnace or heat exchanger, as slides under nuclear shield doors, upside down as a conveyor in heavy die handling carts, in concrete forming for the casting and curing process as well in the launching of heavy segments, attached to a cradle for the launching of huge ships or as a heavy duty wheel-like device to mobilize grandstand seats.

The OT type has an oversized top, the T type has a flush top and the NT type has a long narrow top. The top plates add extra strength to the frame and variety to mounting capabilities, making one type ideal for cavity mount, bolt-on or weld mount. OT and NT Rollers are available with standard top plate sizes and mounting hole pattern, which can be modified to customer specifications.

Elastomeric Preload Pads are available in either fabric impregnated or neoprene form for each roller model.

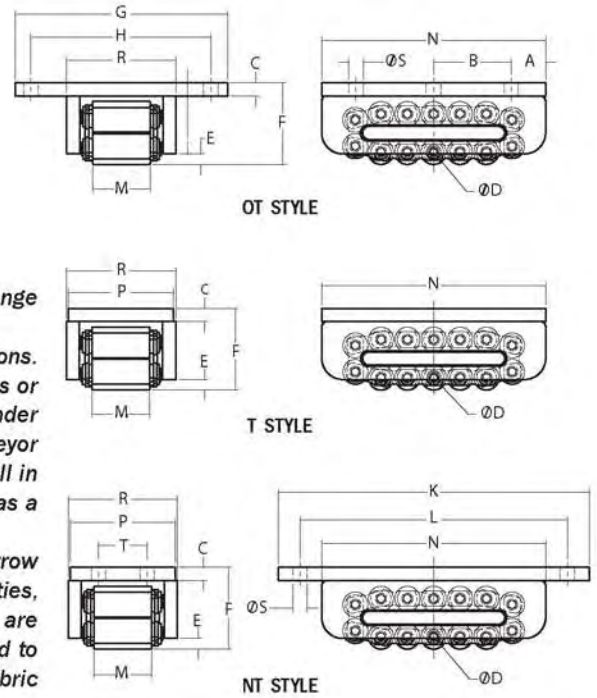

PRODUCT NUMBERS

OT STYLE	NT STYLE	T STYLE	CAPACITY (TONS)	DIMENSIONS (inches / mm)												CONTACT ROLLS			WEIGHT lb / kg					
				A	B	C	D	E	F	G	H	K	L	M	N	P	R	S	T	OT	NT	T		
.75-OT	.75-NT	.75-T	.75	3/4	2-1/2	3/8	11/16	3/8	3-1/8	7	5-1/2	8	7-1/4	2	6-1/2	3-1/2	3-5/8	5/16	2	5	13	11	11	
1-OT	1-NT	1-T	1	1/2	2-1/2	3/8	11/16	3/8	2-3/8	6	4-3/4	8	7	2	6	3-1/2	3-9/16	9/16	1	7/8	5	11	10	9
2.5-OT	2.5-NT	2.5-T	2.5	3/4	2-1/2	3/8	15/16	3/8	3-5/8	7	5-1/2	9-1/2	8	2-7/16	6-1/2	4	4-1/8	9/16	2	4	19	19	17	
5-OT	5-NT	5-T	5	3/4	3-1/4	3/8	15/16	7/16	3-1/8	8	6-3/4	11-3/4	10-1/8	2-7/16	8	4-1/2	4-7/16	9/16	3	5	22	20	19	
8-OT	8-NT	8-T	8	3/4	3-1/4	3/8	15/16	7/16	3-1/8	8	6-3/4	11-3/4	10-1/8	3-5/16	8	5	5-5/16	9/16	3	5	24	24	22	
15-OT	15-NT	15-T	15	1-5/8	3-11/16	5/8	1-3/16	1/2	3-7/8	10	8-1/2	14-3/4	12-11/16	2-3/4	10-5/8	5	5-3/16	11/16	2-5/16	5	47	41	38	
20-OT	20-NT	20-T	20	1-5/8	3-11/16	5/8	1-3/16	1/2	3-7/8	10	8-1/2	14-3/4	12-11/16	4	10-5/8	6-1/2	6-7/16	11/16	3-1/2	5	54	52	47	
37.5-OT	37.5-NT	37.5-T	37.5	2	5-1/2	3/4	1-5/8	5/8	5-1/2	12	10-1/2	21	18-3/4	3-1/2	15	7	7-1/4	13/16	4-1/4	5	119	112	103	
50-OT	50-NT	50-T	50	3-3/4	5-1/2	3/4	1-5/8	5/8	5-1/2	12	10-1/2	22-1/2	20-1/4	3-1/2	18-1/2	7	7-1/4	13/16	4-1/4	7	153	140	134	
75-OT	75-NT	75-T	75	1-1/4	9-1/4	1	1-15/16	1/2	6-3/4	14	11-1/2	27	24	3-5/8	21	7-1/2	7-3/8	1-1/16	5	7	235	210	198	

OT, NT SERIES TURNTABLES OT,NT系列旋轉桌 OT SERIES ROCKER TOPS OT系列擺動頂板



NT with Turntable



OT with LRP

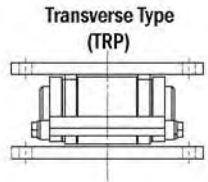
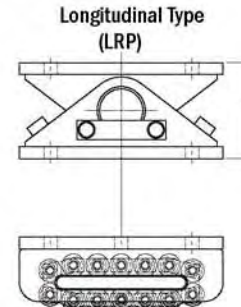
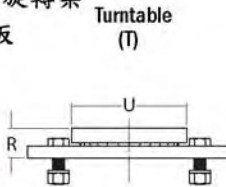

Turntables are available for OT and NT Series rollers in capacities from 5 tons to 75 tons. Turntables bolt to the base roller unit and allow the roller to swivel and provide some freedom of lateral motion in **Roller Accu-Roll** applications where tracks aren't perfectly parallel. Connection hardware is included.

Transverse (TRP) and Longitudinal (LRP) Rocker tops for the OT Series contain two attachment plates connected by a pivot pin assembly. Rockers are designed to be bolted to the base roller unit, then attached to either the load or the surface, enabling the roller to follow an incline or to allow a load to be tilted, launched or more accurately positioned. Connection hardware is included.

Basic OT Roller

PRODUCT NUMBERS		FITS ROLLER MODEL		DIMENSIONS in / mm		WEIGHTS	
TURNTABLES	ROCKERS	LRP	TRP	R	U	TURNTABLES / ROCKERS	
T-OT	T-NT					lb	kg
T-5-OT	T-5-NT	5-LRP	5-TRP	5-OT/NT	1-1/2 38 6 152	4-3/8 111	15 7 36 17
T-8-OT	T-8-NT	8-LRP	8-TRP	5-OT/NT	1-1/2 38 6 152	4-3/8 111	16 8 43 20
T-15-OT	T-15-NT	15-LRP	15-TRP	15-OT/NT	1-1/2 38 6 152	5 127	23 11 101 46
T-20-OT	T-20-NT	20-LRP	20-TRP	20-OT/NT	1-1/2 38 6 152	5 127	23 11 120 55
T-37.5-OT	T-37.5-NT	37.5-LRP	37.5-TRP	37.5-OT/NT	2-3/8 60 8 203	6-1/2 15	54 25 196 89
T-50-OT	T-50-NT	50-LRP	50-TRP	50-OT/NT	2-3/8 60 8 203	7 178	54 25 196 89
T-75-OT	T-75-NT	75-LRP	75-TRP	75-OT/NT	2-3/8 60 8 203	9-1/4 235	85 39 390 173

SHD系列(重結構滾輪)

SHD SERIES

個別滾輪100~1000噸

INDIVIDUAL ROLLERS 100-1000 TONS



Heavy structures skate almost effortlessly on SHD Series (Super Heavy Duty) Rollers! With load capacities from 100 to 1000 tons per unit, virtually any load is transportable. Typical applications range from installing steam generators or precipitators, rolling entire bridges, advancing launching trusses, skidding drill works aboard offshore rigs, even relocating entire multi-story structures!

The same top plate configurations are available as for **Roller's** OT, T and NT Series. The "T" style top is flush with the frame body width and length. The "NT" style top overhangs the body at the ends. The "OT" style top overhangs the body sides. 150 and 200 ton SHD Series Rollers have long frame and wide frame configurations as well. Standard hole patterns are supplied in the OT and NT versions. The user can specify no holes if preferred. Special modifications, such as drilled and tapped holes, short or wide versions are also available.



CAPACITY (TONS)	PRODUCT NUMBER	HEIGHT		TOP PLATE WIDTH		TOP PLATE LENGTH		WEIGHT		CONTACT ROLLS
		in	mm	in	mm	in	mm	lb	kg	
100	100-XT	6-3/4	171	8	203	21	533	217	98	7
150	150-XTL	6-3/4	171	8	203	32	813	329	149	11
150	150-XTW	6-3/4	171	9-7/8	251	21	533	307	139	14
200	200-XTL	6-3/4	171	8	203	36	914	384	174	14
200	200-XTW	6-3/4	171	12	305	21	533	313	142	14
200	200-XTWC	6-3/4	171	14-1/2	368	21	533	387	176	14
300	300-XT	10	254	10-3/4	273	34	864	706	320	8
500	500-XT	10	254	20	508	34	864	1290	585	16
750	750-XT	consult factory for specifications and weights								
1000	1000-XT	consult factory for specifications and weights								
100	100-XNT	6-3/4	171	8	203	27	686	242	110	7
150	150-XNLT	6-3/4	171	8	203	38	965	365	166	11
150	150-XNTW	6-3/4	171	9-7/8	251	27	686	280	127	14
200	200-XNTL	6-3/4	171	8	203	42	1067	396	180	14
200	200-XNTW	6-3/4	171	12	305	27	686	333	151	14
200	200-XNTWC	6-3/4	171	14-1/2	368	27	686	408	185	14
300	300-XNT	10	254	10-3/4	273	42	1067	739	335	8
500	500-XNT	10	254	20	508	42	1067	1355	615	16
750	750-XNT	consult factory for specifications and weights								
1000	1000-XNT	consult factory for specifications and weights								
100	100-XOT	6-3/4	171	14	356	21	533	250	113	7
150	150-XOTL	6-3/4	171	14	356	32	813	399	181	11
150	150-XOTW	6-3/4	171	16	406	21	533	299	136	14
200	200-XOTL	6-3/4	171	14	356	36	914	463	210	14
200	200-XOTW	6-3/4	171	21	533	21	533	364	165	14
200	200-XOTWC	6-3/4	171	21	533	21	533	423	192	14
300	300-XOT	10	254	21	533	34	864	849	385	8
500	500-XOT	10	254	30	762	34	864	1430	649	16
750	750-XOT	consult factory for specifications and weights								
1000	1000-XOT	consult factory for specifications and weights								

ACCU-ROLL 導輪系統

ACCU-ROLL GUIDANCE SYSTEMS

- EXTERNAL GUIDANCE 外部導輪
- UPLIFT PREVENTION 防止升起導輪
- ALIGNMENT ASSURANCE 確信成線排列

Accu-Roll Guidance System, a positive external alignment option, can be added to any **Roller** as either a removable bolt-on or permanent weld-on system. In applications where load alignment is critical, or close tolerances, repetitive movement or uplift prevention are required, **Accu-Roll** often becomes an ideal solution to these heavy motion issues. Depending on the configuration selected, **Accu-Roll** will allow the roller to track precisely on a flat bar, I-Beam, rail or in a channel or trench. **Accu-Roll** on an OT or NT Roller combined with a turntable can allow the roller to follow a slightly skewed track. **Accu-Roll Guidance Systems** are custom made and available with a wide range of options and in various configurations for virtually any situation or application. Consult factory for recommendations.

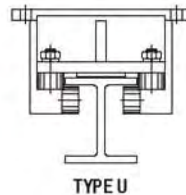

TYPE U

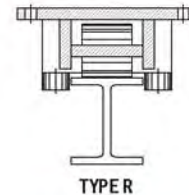

TYPE R

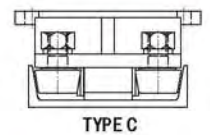

TYPE C



"C" System for Channel Roller shown in channel

"R" & "U" Systems for I-Beam Guidance and Uplift Prevention



"R" for Rail Roller shown on I-Beam

WARRANTY 保固

WARRANTY

We warrant each new FT, ERS, and Nyton chain-action Roller sold by us to be free from manufacturing defects in normal service for a period of five (5) years commencing with delivery of the roller to the original user. All other products manufactured by **HILMAN** retain a one (1) year **QUALITY** warranty. Our obligation under this warranty is expressly limited at our option, to the replacement or repair at **Hilman Rollers, Marlboro, New Jersey** 07746 USA, or at a service facility designated by us, of such part or parts as inspection shall disclose to have been defective. This warranty does not apply to defects caused by damage or unreasonable use, including failure to provide reasonable and necessary maintenance, while in the possession of the consumer.

WE SHALL NOT BE LIABLE FOR CONSEQUENTIAL DAMAGES OF ANY KIND, including, but not limited to, consequential labor costs or transportation charges in connection with the replacement or repair of defective parts. We make no warranty with respect to trade accessories. They are subject to the warranties of their manufacturers.

THERE ARE NO WARRANTIES EXCEPT AS ABOVE STATED. HILMAN DISCLAIMS AND EXCLUDES ANY IMPLIED WARRANTY OF MERCHANTABILITY OF ITS GOODS OR WARRANTY OF THE FITNESS OF THOSE GOODS FOR ANY PURPOSE OR USE. Subject to the express one-year warranty provided for the repair or replacement of defective goods, the customer acknowledges that it makes its purchase in reliance upon customers' inspection of the goods purchased from **Hilman** and not by reason of any representations made by or on behalf of **Hilman**.

We make no other express warranty, nor is anyone authorized to make any on our behalf. Any and all claims arising against **Hilman** Rollers or subsidiaries or affiliated firms concerning the use of the **Hilman** Rollers shall be governed by the laws of the State of New Jersey in the USA.

We Have Been Moving Your Heavy Loads For Over 50 Years! 我們已移動荷重物超過50年了

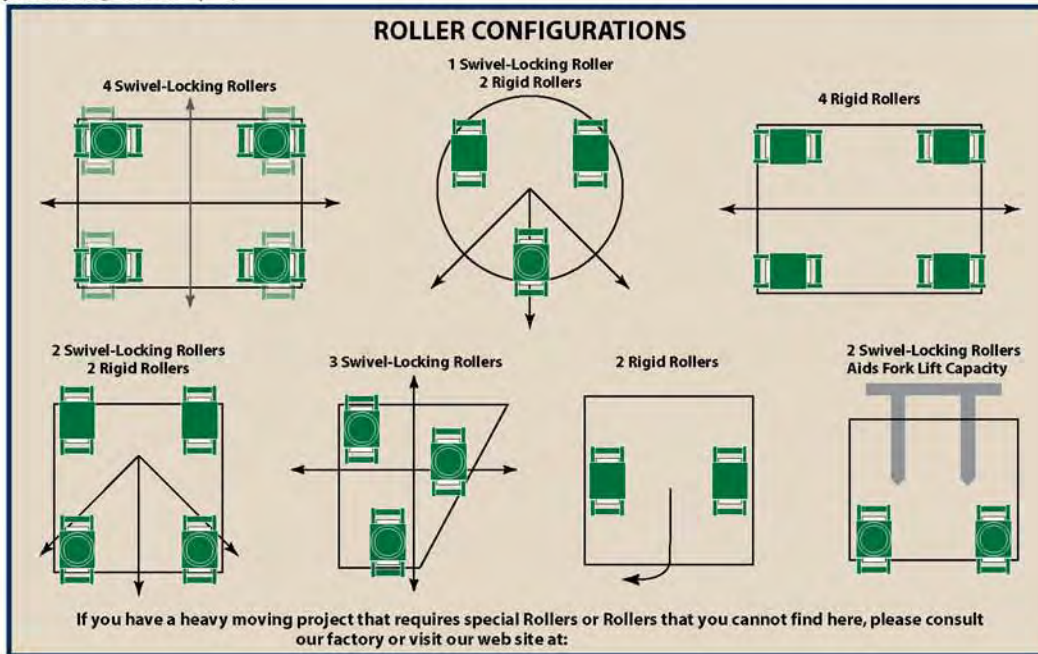

Write us or ask your distributor for these other



Engineered Products & Systems for Heavy Moving Projects



Tri-Glide 3-Point Heavy Moving System for All Types of Floors

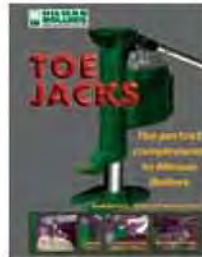

Toe Jacks - The Perfect Complement to Roller

ROLLERS brochures:

Rollers At Work Series



- Oil & Gas Exploration • Marine and Shipbuilding
- Bridge Construction
- Heavy Construction & Rigging • Pipe and Tunneling
- Power Generation • Nuclear Facilities
- Research Equipment
- Manufactured Home Production and Roll-On
- OEM, Production & Automation, Quick Die Changing
- Industrial Machinery

Your Authorized

ROLLERS Distributor Is:

